

高清高速球型网络摄像机

High Speed Dome Network Camera

KEDACOM

快速安装指南

Quick Start Guide

一 前言

感谢您购买我司产品，如对本公司产品有疑问或需要，请随时和我们联系。

此内容（手册）的目的是确保用户正确使用本产品，以避免危险或财产损失。在使用产品之前，请认真阅读此手册并妥善保存以备日后参考。如果用户因没有按照以下安全说明，致使设备不能正常使用或损坏等情况，我司恕不负责，感谢您的配合。

二 安全说明

1. 电源要求

- 请在安装使用设备过程中，严格遵守当地各项电气安全规定。
- 请使用满足安全电压要求的电源，在设备运行之前检查供电电源是否正确。
- 请在安装配线时装入易于使用的断电设备，以便必要时进行紧急断电。
- 请保护电源软线免受踩踏或紧压，特别是在插头、电源插座和从装置引出的接点处。
- 请在断电状态下连接网络、电源等线缆，严禁在设备上电的情况下连线。

2. 使用环境要求

- 请勿将摄像机对准强光（如灯光照明、太阳光等处）聚焦，否则容易引起过亮或漏光现象（这并非摄像机故障）也将影响摄像机寿命。
- 请在允许的湿度和温度范围内运输、使用和存储设备。
- 请勿将设备置于潮湿、多尘、极热、极冷、强电磁辐射或照明条件不稳定等场所。
- 请勿让任何液体流入设备，以免内部元件受损。
- 请在运送设备时，重新以出厂时的包装进行包装，或用同等品质的材质包装。
- 请勿在运输、存储及安装过程中重压、剧烈震动、浸泡设备。
- 请勿安装在不牢固的支架、墙面、或屋顶上，否则会导致人机受损。

工作环境		
供电要求	AC 24V±10%，50~60Hz	
环境要求	防水、防干扰、防雷击	
温湿度	工作温度	-40°C~70°C（室外球） -25°C~60°C（室内球）
	工作湿度	10%~95%(相对、无凝结)

3. 日常维护与保养

- 请勿直接触碰设备发热部件，以免烫伤。
- 镜头玻璃沾染灰尘或油脂时，用棉布或镜头清洁布擦拭。若遇污垢难以清除，蘸上少量镜片清洁液，自镜头中心向外旋转轻轻擦拭，直到干净为止。禁止使用有机溶剂（苯、酒精等）对镜头玻璃和护罩前脸进行除尘、清洁。
- 请不要以任何方式拆卸或修改产品（对未经认可的修改或维修导致的问题，本公司不承担任何责任）。
- 如果设备工作不正常，请联系经销商或最近的服务中心。

4. 特别声明

- 本手册中的图示仅供参考，产品请以实物为准。
- 我们尽最大努力来保证本手册信息的正确性，如因升级等原因发生信息修改，恕不另行通知。本手册能作为多个型号产品的使用指导，但并不一一列举每个产品的使用情况，请您根据实际产品自行对照。
- 本产品使用 IPCSearch 激活后方能使用（IPCSearch可在官网下载，下载链接 <https://www.kedacom.com/cn/softtools/index.jhtml>），激活时请填写有效邮箱，方便找回密码。强烈建议您将密码设置为强密码：由数字、大/小写字母或特殊符号中两种或两种以上类型组合而成，且密码长度满足 8-16 位。请您定期更改用户名的密码，建议每 3 个月更新一次密码。如果设备在较高安全风险的环境中使用，建议每月或每周更新一次。请妥善保管好您的用户名与密码。
- 如需获取最新文档，请至官网下载，官网地址 www.kedacom.com。

部件说明

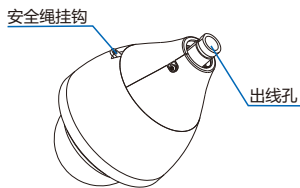
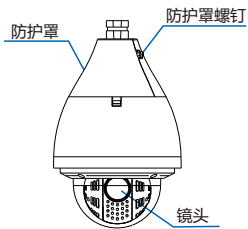

室外球

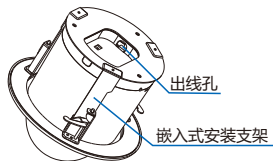
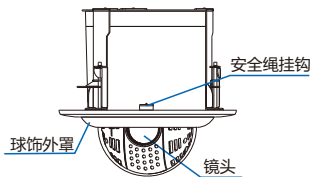

室内球 (有球罩)

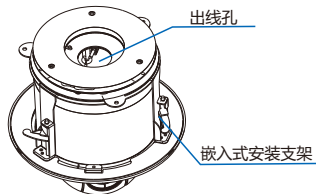
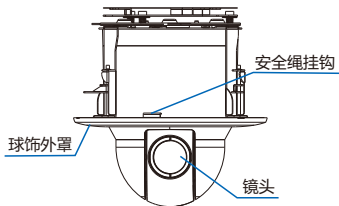

室内球 (无球罩)

尾线图

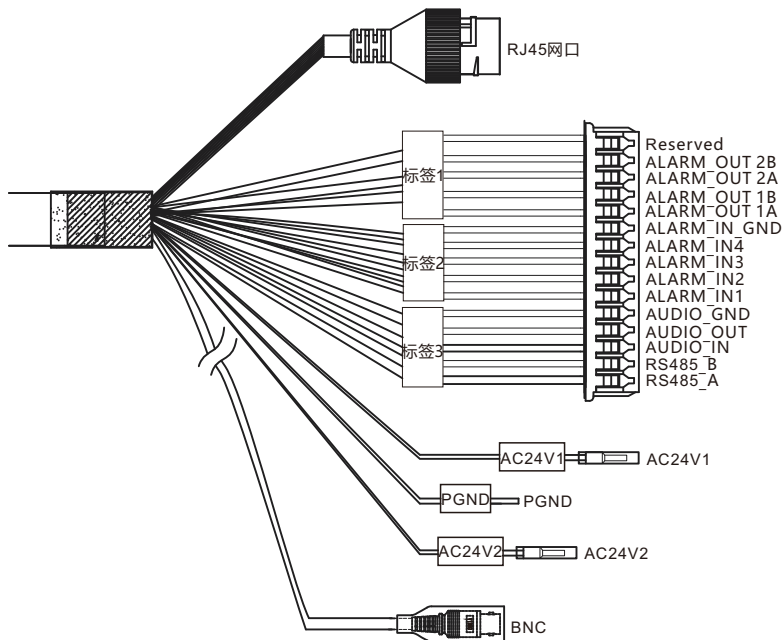

- 【说明】** 1)具体线缆连接以实际设备上所贴线缆标签为准。
2)部分产品支持 POE 供电，具体请以实际购买产品为准。

标签	颜色	功能说明	线序
RJ45网口	-	RJ45 网口，连接网络设备，支持 10/100Mbps 自适应	-
RS485_A	黑	RS485 串口，与外接设备交互控制，如控制第三方设备。	1
RS485_B	红		2
AUDIO_IN	灰	音频输入，输入音频信号，连接拾音器等设备	3
AUDIO_GND	黄	音频接地	4
AUDIO_OUT	蓝	音频输出，输出音频信号，连接音箱等设备	5
ALARM_IN1	白	告警输入，输入告警信号，连接声控开关等设备	6
ALARM_IN2	紫		7
ALARM_IN3	橙		8
ALARM_IN4	棕		9
ALARM_IN_GND	绿	告警输入接地	10
ALARM_OUT 1A	黑/白	告警输出，输出告警信号，端子不分正负。连接报警灯等设备。	11
ALARM_OUT 1B	红/白		12
ALARM_OUT 2A	粉红		13
ALARM_OUT 2B	棕/白		14
Reserved	紫/白	悬空保留	15
AC24V1	红	电源，连接 AC24V 电源	-
PNGD	黄绿	保护接地	-
AC24V2	黑	电源，连接 AC24V 电源	-
BNC	-	视频输出，本地视频输出复合视频信号	-

【说明】 不同子型号线缆规格有区别，请用户根据线缆数量参照表格进行识别。

四 设备安装

1. 安装注意事项

- 墙壁/天花板厚度可支持安装膨胀螺钉。
- 确认安装地点有容纳本产品及其安装结构件的足够空间。
- 请确保安装摄像机的墙面、横杆等的承受能力必须能支撑摄像机及其安装结构件重量的8倍（室外球大净重：4.5Kg；室内球最大净重：2.1Kg）。
- 没有限高通行的路段，建议外延摄像机的安装高度不低于5米，减少摄像机被碰擦风险。
- 防止设备掉落，安装摄像机时必须安装安全绳。
- 施工期间禁止人员在摄像机下方2米内活动，并佩戴好安全帽等防护装备。

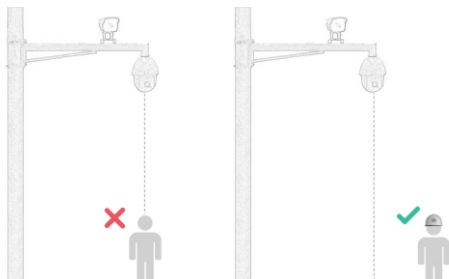

2. 安装存储卡

1) 打开球机透明罩，取出防震泡棉，撕掉保护贴纸，按需安装 SD 卡：

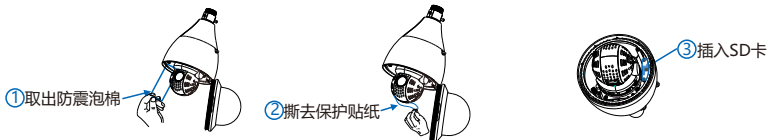

【说明】部分型号 SD 卡槽位置与图示略有不同，根据实际情况安装。

2) 套上球机透明罩，并拧紧螺钉固定。

【注意】下球罩容易划伤，请在安装步骤全部完成之后再撕去表面的保护膜。

3. 室外球安装

室外球设备支持壁装、吊装、墙角支架安装、抱柱支架安装和自制支架安装。

【说明】支架均为选配配件。

壁装支架安装

- 1) 将线缆从支架穿出，线缆请留出足够长度，以便连接到球机内线缆（推荐预留 20cm~30cm）；
- 2) 根据安装贴纸在墙面打好孔并塞入膨胀螺钉，将支架底座的孔对准墙面上的孔，放入螺钉，锁紧；

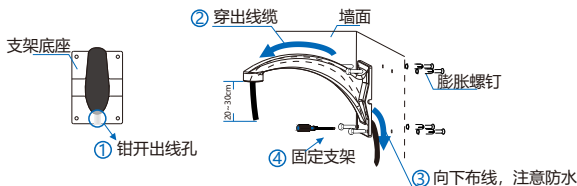

支架底座出线

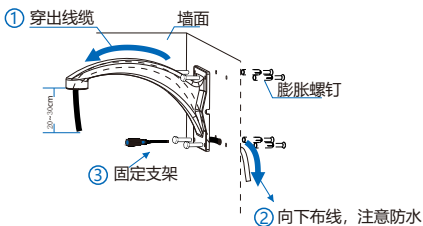

穿墙出线

- 3) 在转接件螺纹处缠上生料带，将转接件旋紧到安装支架上，锁紧支架上的销钉，并确认转接件上防脱螺钉处于非锁紧状态；

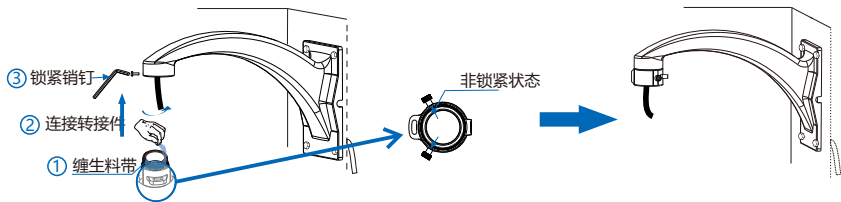

4) 取出安全挂钩，将一端预先挂扣在转接件的挂耳上。

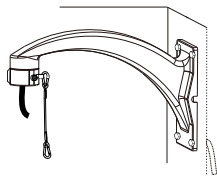

5) 拧开对开式防护罩上螺钉，按标签指示方向旋转，再向相反方向掰开对开式防护罩；

【说明】对开式防护罩内有防坠绳与球机相连，后续安装图示仅作为示意图。



6) 先将支架上的安全挂钩另一端挂扣到球机上，线缆穿过上球罩；球机安装柄的 D 字直边对准转接件上的标签后，将球机上推进转接件底部并旋转 180° 至黄色标签对齐，此时球机已固定。最后锁紧两颗防脱螺钉。

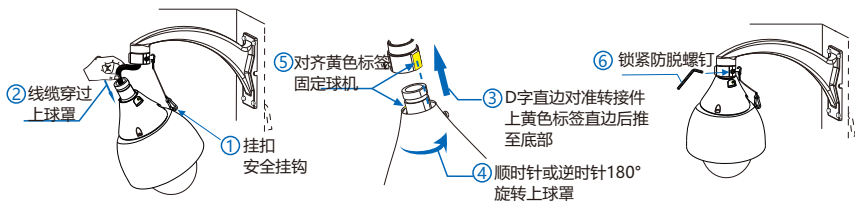

7) 拧开上球罩上两颗固定螺钉，打开上球罩；



8) 按照球罩内所贴标签连接线缆，连接完成后检查并整理各类线缆，然后用绝缘胶布缠绕牢固，做好避水弯；

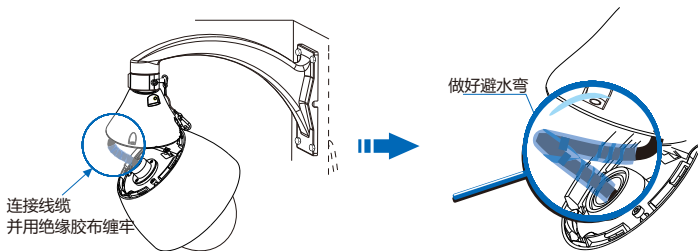

9) 务必将线缆整理好并用束带捆绑住，束带穿过束带固定件并拉紧束带；

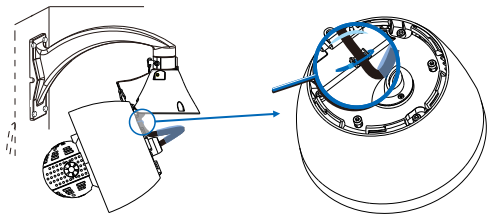

10) 盖 upper 球罩并拧紧 upper 球罩上两颗固定螺钉；

11) 装套防护罩：对接紧密对开式防护罩后，对齐球罩上圆点，旋转至标签对齐，拧紧对开式防护罩上的螺钉；

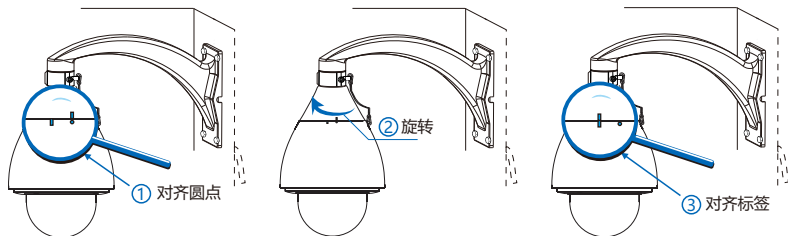

12) 安装完成后，撕掉表面的保护膜，设备上电。

吊装支架安装

装配转接件及球机步骤参照壁装支架。

- 1) 将线缆从支架穿出，线缆请留出足够长度，以便连接到球机内线缆（推荐预留 20cm~30cm）；
- 2) 根据安装贴纸在墙面打好孔并塞入膨胀螺钉，将支架底座的孔对准墙面上的孔，放入螺钉，锁紧。

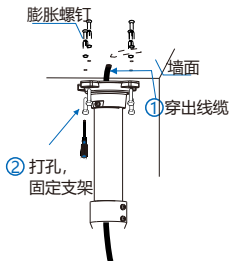

墙角支架安装

装配转接件及球机步骤参照壁装支架。

- 1) 将线缆从支架穿出，线缆请留出足够长度，以便连接到球机内线缆（推荐预留 20cm~30cm）；
- 2) 根据墙角装支架的安装孔位为模板，在墙壁上画出安装孔位置，打出安装孔，并塞入膨胀螺钉，固定墙角装支架；
- 3) 将壁装支架底座的孔对准墙角装支架上的孔，放入螺钉，锁紧。

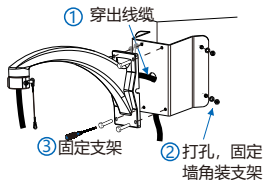

抱柱支架安装

装配转接件及球机步骤参照壁装支架。

- 1) 旋开抱柱支架卡箍；
- 2) 将线缆从支架穿出，线缆请留出足够长度，以便连接到球机内线缆（推荐预留 20cm~30cm）；
- 3) 将抱柱支架固定到安装柱上，拧紧卡箍固定支架；
- 4) 将壁装支架底座的孔对准抱柱支架上的孔，放入螺钉，锁紧。

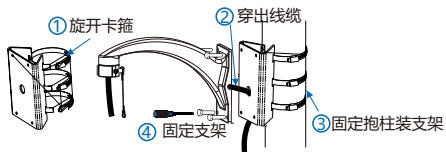

自制支架安装

用户可自制带销钉（至少 2 个）的支架安装摄像机，本手册以横杆为例。

- 1) 准备已经焊接好安装接口的横杆，距安装接口 10mm~13mm 处须安装有至少 2 个销钉；

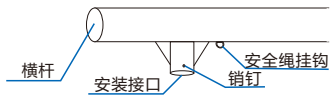

- 2) 将线缆从支架穿出，线缆请留出足够长度，以便连接到球机内线缆（推荐预留 20cm~30cm）；

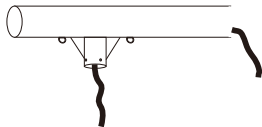

- 3) 取出安全绳，将安全绳挂钩一端预先挂扣在横杆挂钩上；

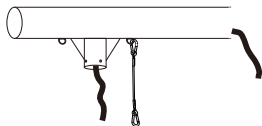

- 4) 球机安装步骤参照壁装支架安装。

4. 室内球安装

室内球设备支持嵌入式安装和吸顶式安装。

嵌入式安装

嵌入式安装前需安装存储卡，步骤参见安装存储卡章节。

【说明】 嵌入式支架为选配配件。

- 1) 装配支架：对准出线孔，用螺钉固定支架；
- 2) 将安装辅助贴纸贴在天花板上，开出相应孔洞；
- 3) 按球罩上所贴标签连接线缆，连接完成后检查并整理各类线缆，然后用绝缘胶布缠绕牢固；
- 4) 请将线缆整理好并用束带捆绑住，束带穿过束带固定件并拉紧束带；

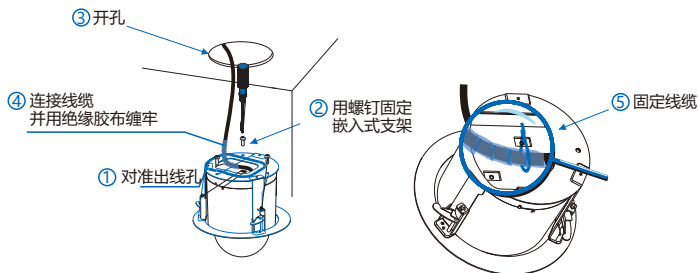

- 5) 将设备推入孔洞中，调整至合适位置后锁紧螺钉使支撑片夹紧天花板；

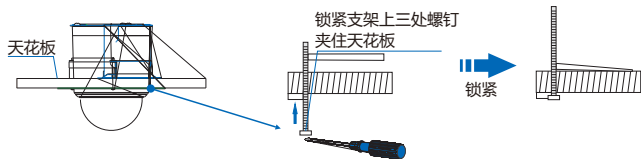

- 6) 安装装饰外罩。

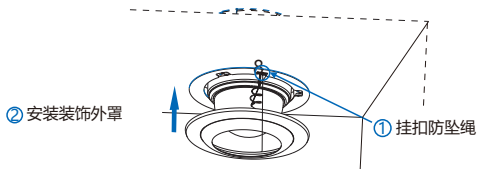

吸顶式安装

- 1) 旋转并取下外罩，安装存储卡，步骤参见安装存储卡章节；
- 2) 确定安装位置后，将安装辅助贴纸贴在天花板上，根据标记打孔并塞入膨胀螺钉；

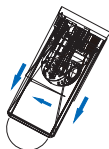

旋转并取下外罩

- 3) 按球罩上所贴标签连接线缆，连接完成后检查并整理各类线缆，然后用绝缘胶布缠绕牢固；
- 4) 请将线缆整理好并用束带捆绑住，束带穿过束带固定件并拉紧束带；

- 顶部出线：必须在安装面上预留线孔，将尾线引出即可。
- 侧面出线：用老虎钳在底座钳开出线孔，将尾线引出即可。

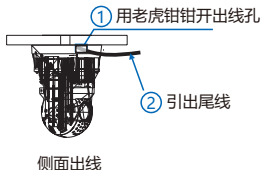
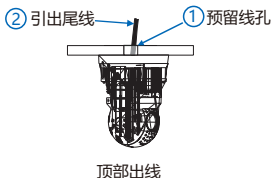

- 5) 处理好线缆后，用3颗自攻螺钉将设备底座固定在天花板上；
- 6) 装配外罩时，使外罩上的凸起对准底座上的凸起，推至紧密结合并按图示方向转至标示处。

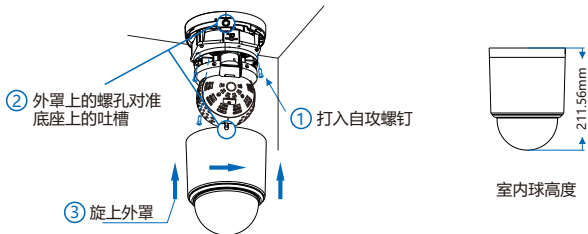

五 登录客户端

最低配置和系统环境

- 处理器：3.3GHz 酷睿®i2 系列及以上或相同性能的其他处理器
- RAM内存：4GB 及以上
- 操作系统：WindowsXP 操作系统或更高版本
- 浏览器：推荐使用 IE 内核浏览器，使用其他内核浏览器会影响客户端部分功能的使用
- DirectX：9.0c

激活设备

第一次使用时请运行 IPCSearch，在 IPCSearch 中将显示设备的 IP 地址、网关等信息。若设备所接入的网络有 DHCP 服务，DHCP 服务器将自动给设备分配 IP 地址。

- 批量激活：在 IPCSearch 中选中设备，点击**批量处理**，在弹出的界面中设置 admin 用户的密码和找回密码时所需的邮箱，点击**激活**，激活设备。待设备重启。
- 单个激活：在 IPCSearch 中选中设备，单击右键，选择设备激活。填写用户名、密码、找回密码时所需的邮箱，点击**激活**，激活设备。待设备重启
- Web 客户端激活：也可以通过 Web 端激活。将 PC 机与设备设为同一网段，进入 Web 端登录界面。可在该界面设置管理员密码和找回密码所需的邮箱，点击**激活**，激活设备。

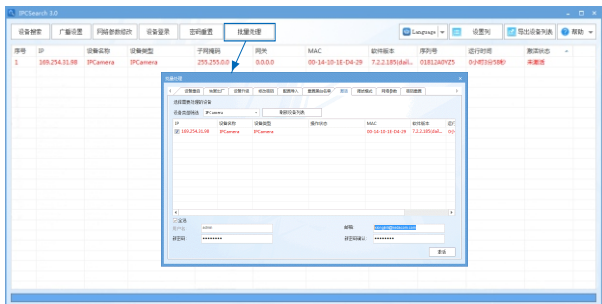

修改设备IP

点击**网络参数修改**，在弹出的界面中配置网络参数。静态分配IP地址时，请选择自定义地址，填写以太网参数。修改参数配置，需要填写管理员用户用户名（admin）及激活设备时所设置的密码。完成IP配置后，设备将自动重启，重启时间约为60秒。

登录设备

- 1) 在IPCSearch中双击设备或点击设备登录，输入用户名和密码，登录Web端。
- 2) 登录成功后，下载并安装视频插件。
- 3) 进入Web端后，可直接浏览图像。

【说明】不同型号的设备，Web 端浏览界面略有差异，请以实际界面为准。更多客户端说明请参考客户端帮助文档。

调整设备方向，在 Web 端进行参数调整，直到浏览画面达到预定要求。

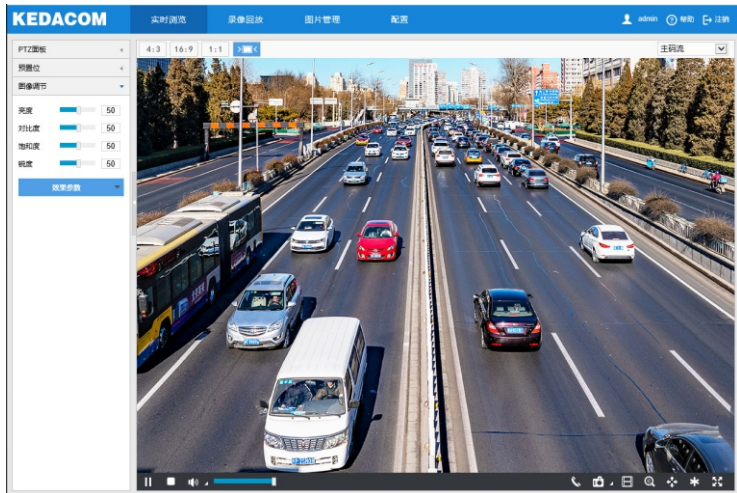

附录一

防水

- 室外安装推荐使用支架横臂有一定向上角度的壁装支架。
- 用户自选支架安装推荐使用接口为内螺纹的支架，同时须确保支架的防水性能；用户自选支架安装若选用外螺纹支架，须确保支架与球机连接的转接器件的防水性能。
- 安装时螺纹口需缠绕生料带，并确保螺纹密封；安装时对准螺纹，不能出现明显偏位及滑丝。
- 球机透明球罩上的密封胶圈必须安装，防止水蒸气及灰尘进入设备。

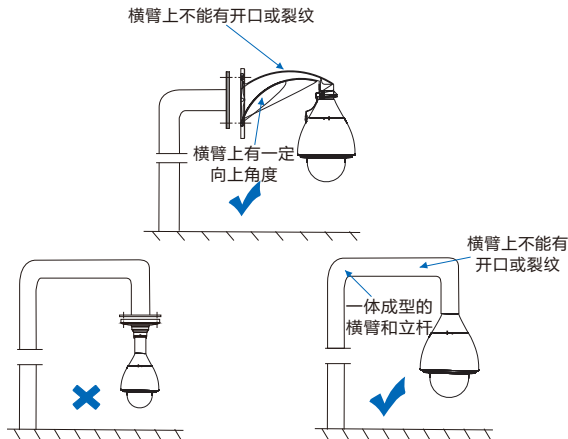

防静电、防干扰、防雷、防浪涌

- IPC 安装不进行接地可能会因为静电造成电子器件损坏。
- 在雷电多发地区，需要对IPC进行就近接地，释放雷击等高能能量，防止IPC 损坏。
- 在电压不稳地区，需要对IPC进行接地，释放浪涌等高能能量，防止IPC电源烧坏。
- IPC 安装防雷接地线不能替代安全接地线。在采用接地不良的立杆，如木杆、水泥杆，需要安装安

全接地线，泄放漏电流以确保 IPC 或立杆不引起安全事故。

- IPC 安装防雷接地线不能借用附近的其他电子设备接地线入大地，必须单独接地。

【水泥杆接地】

水泥杆方式需要配置钢管护套用于接地线穿管，如图所示，球机接地线从钢管内部穿过接地。控制中心本地进行规范接地即可。

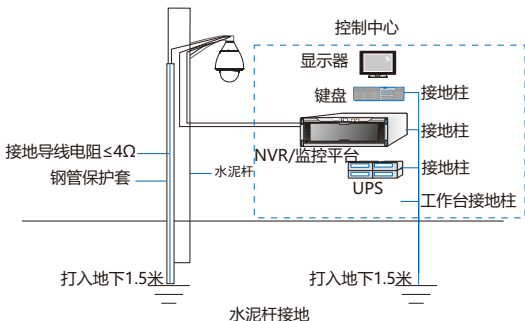

【金属杆接地】

金属杆方式采取 PVC 管穿接地线。没有安装避雷针的金属立杆，采用接地线（穿 PVC 管套）靠近金属杆的位置固定后实施接地，如图所示。

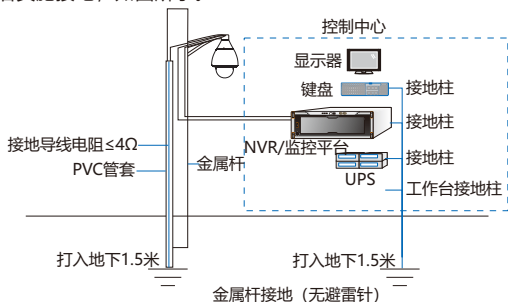

安装了避雷针的金属杆，采用金属杆内穿接地线（穿 PVC 管）的方式接地，且 PVC 管需要与金属杆内壁保持尽量大的绝缘距离，如图所示。

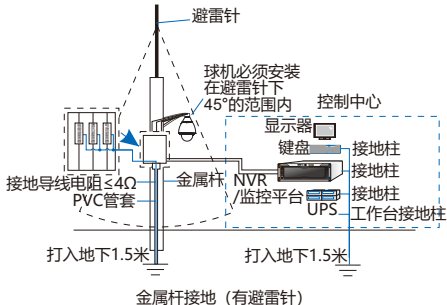

【注意】 如果 IPC 传输过程中使用了光端机或者防雷器等中间件，需确保中间件接地良好，同时需确保 IPC 的连接线缆通过中间件也能接地良好。

附录二 AC 24V 线径与传输距离关系表

当线径大小一定, AC 24V 电压损耗率低于 10% 时, 不同传输功率推荐的最大传输距离。(对于 AC 24V 交流供电设备, 其最大允许电压损耗率为 10%。下面表格中所用线缆均为铜线, 铜的电阻率为 $\rho = 0.0175\Omega \cdot \text{mm}^2/\text{m}$)

距离m (feet) 功率W	0.8 (20AWG)	1.0(18AWG)	1.25(16AWG)	2.0(12AWG)
5	122 (401)	194 (636)	307 (1008)	781 (2562)
10	61 (201)	97 (318)	154 (504)	391 (1281)
15	41 (134)	65 (212)	102 (336)	260 (854)
20	31 (100)	48 (159)	77 (252)	195 (641)
25	24 (80)	39 (127)	61 (202)	156 (512)
30	20 (67)	32 (106)	51 (168)	130 (427)
35	17 (57)	28 (91)	44 (144)	112 (366)
40	15 (50)	24 (79)	38 (126)	98 (320)
45	14 (45)	22 (71)	34 (112)	87 (285)
50	12 (40)	19 (64)	31 (101)	78 (256)
55	11 (36)	18 (58)	28 (92)	71 (233)
60	10 (33)	16 (53)	26 (84)	65 (214)
65	9 (31)	15 (49)	24 (78)	60 (197)
70	9 (29)	14 (45)	22 (72)	56 (183)
75	8 (27)	13 (42)	20 (67)	52 (171)
80	8 (25)	12 (40)	19 (63)	49 (160)
85	7 (23)	11 (37)	18 (59)	46 (151)
90	7 (22)	11 (35)	17 (56)	43 (142)
95	6 (21)	10 (33)	16 (53)	41 (135)
100	6 (20)	10 (32)	15 (50)	39 (128)

【备注】 线径要求适用于单根、实心、圆形的铜线, 多股绞线的电缆 AWG 值是由所有线的总横截面积决定。

保修说明

本保修卡适用于您购买的本公司系列产品。

- 1.终身保质，免费保修期一年（仅限中国大陆地区，中国大陆以外地区请参考英文说明）。
- 2.凡保修期内，由于本产品自身引起的故障，请与公司售后服务部联系。
- 3.保修时我们将使用您的保修卡信息，请认真填写。
- 4.以下情况，属于有偿保修范围：
 - 人为原因造成的设备故障
 - 因使用环境不符合本产品要求造成的故障
 - 因不可抗力造成的产品损坏
 - 无保修卡
 - 已过保修期

用户信息

用户名称：

详细地址：

传真：

电话：

邮箱：

邮编：

产品名称：

产品型号：

购买日期：

I. Preface

Thank you for purchasing our product. If there are any questions, or requests, please do not hesitate to contact us.

The intention of writing this Guide is to ensure that user can use the product correctly to avoid danger or property loss. Please read this Guide carefully before using, and keep it properly for future reference. If the product cannot work normally or is damaged because the user does not follow the safety instructions, we shall not assume any responsibility. Your cooperation will be highly appreciated.

II. Safety Instruction

1. Power Supply

- During installing and using the device, please follow local electrical safety regulations strictly.
- Please use power supply in the safe voltage range of our product. Make sure if the power supply is correct before running the device.
- Please install an easy-to-use breaker during installation and wiring in case it is necessary to make an emergency break.
- Please prevent the power cord from being trampled or pressed especially the plug, socket and the connecting part led out from the device.
- Please connect cables of power, alarm, audio and RS-485 with the power off. Hot-line wiring is not allowed.

2. Working Environment

- Do not focus the camera lens on strong light such as the sun or incandescent lamp; otherwise the strong light will cause overexposure or light leak (not camera malfunction), which may shorten camera lifetime.
- Please transport, use and store the device within defined humidity and temperature ranges.
- Do not expose it in damp, dusty, extremely hot or cold places or places with intense electromagnetic radiation or with unstable lighting.
- Keep the camera away from water or any liquid to avoid damage to internal components.
- While shipping the camera, pack it in the factory packing or use materials with equivalent quality.
- When shipping, storing and installing the device, try to prevent it from damages caused by pressure, violent vibration and soaking.
- Please do not install the device on unstable bracket, wall or roof; otherwise it may damage people and the device.

Working Environment	
Voltage	AC24V±10%, 50~60Hz
Condition	Waterproof, lightning protection, anti-interference
Working Temperature	-40°C~+70°C (outdoor dome camera); -25°C~+60°C (indoor dome camera)
Humidity	10%~95% (Relative, non-condensing)

3. Daily Maintenance

- Do not touch the heat component of the device directly to avoid empyrosis.
- When the lens is contaminated by dust or grease, use cotton cloth or lens clean cloth to wipe it off. When it is hard to clean, dip some lens cleanser and wipe gently and rotate outward from the middle until it is clean. Never apply any organic solvent with ethanol or benzene to clean the lens and housing.
- Do not disassemble or repair the device in any way by yourself. We shall not assume any responsibility for problems caused by unauthorized repair or maintenance.
- When it is necessary to replace a part, please contact your dealer in advance and replace the part with specific model or part of the same features. We shall not assume any responsibility for problems caused by unauthorized replacement.
- If the product does not work properly, please contact your dealer or the nearest service center.

4. Special Statement

- The product appearance is subject to the actual device and picture in this Guide is for reference only.
- Every effort has been made to ensure the accuracy and validity of this Guide. Any update of this Guide caused by version upgrade is subject to change without notice.
- This device can be used after being activated through IPCSearch (download it from our website: <https://www.kedacom.com/cn/softtools/index.jhtml>). During activation please fill a valid email address for finding back the password.
- To ensure the safety of device on internet, it is strongly recommended that you set a strong password which is composed of at least 2 kinds of the following, digits, case-sensitive letters or specific symbols, and whose length ranges from 8 to 16 bits. Please modify the password periodically and once every 3 months is recommended. If the device is used in highly risky environment, suggest modifying the password monthly or weekly. Please keep your user name and password safe.
- For the latest files, please download from our website www.kedacom.com.

III. Appearance

Dimensions

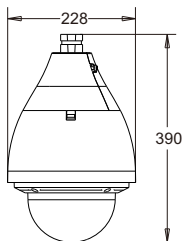

Outdoor Dome Camera

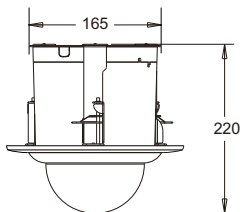

Indoor Dome Camera (with dome)

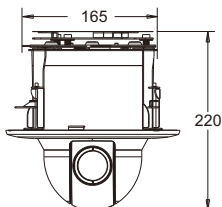

Indoor Dome Camera (without dome)

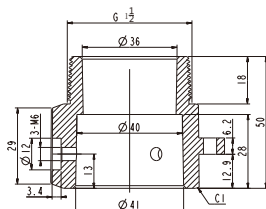

Size of Connector

Unit: mm
Weight: 4.5 KG Max (outdoor)
2.1 KG Max (indoor)

Components

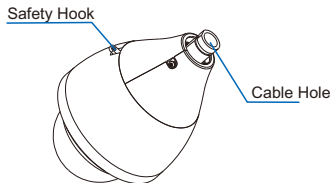
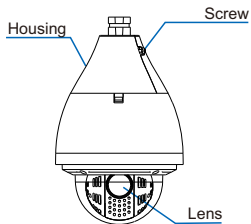

Outdoor Dome Camera

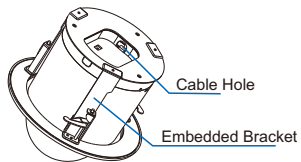
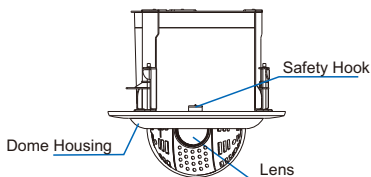

Indoor Dome Camera (with dome)

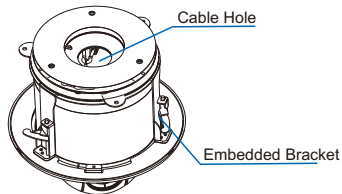
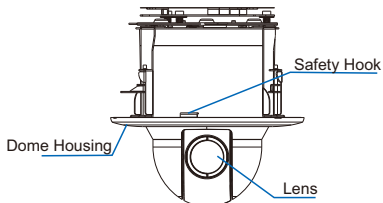

Indoor Dome Camera (without dome)

Tail Wire

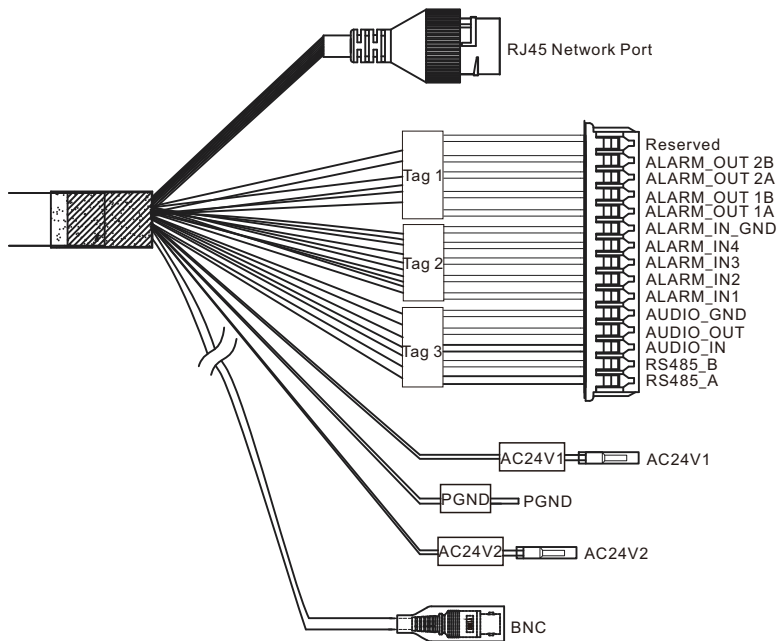

[Note]:

- 1) Wire connection should subject to the actual wire tags on the device.
- 2) Only some models support PoE. Please subject to the actual models purchased.

Tag	Color	Function	No.
RJ45 Port	-	RJ45 port, connect to network device, support adaptive 10/100Mbps	-
RS485_A	Black	RS-485 serial port, connect to external devices for control such as controlling a third-party device	1
RS485_B	Red		2
AUDIO_IN	Gray	Audio input, inputting audio signal; connect to sound pick-up	3
AUDIO_GND	Yellow	Audio grounding port	4
AUDIO_OUT	Blue	Audio output port, for outputting audio signal; connect to loudspeaker	5
ALARM_IN1	White	Alarm input port, for inputting alarm signal; connect to voice-operated switch and etc.	6
ALARM_IN2	Purple		7
ALARM_IN3	Orange		8
ALARM_IN4	Brown		9
ALARM_IN_GND	Green	Alarm input grounding port	10
ALARM_OUT 1A	Black/White	Alarm output port, for outputting alarm signal, regardless of positive or negative poles; connect to alarm light	11
ALARM_OUT 1B	Red/White		12
ALARM_OUT 2A	Pink		13
ALARM_OUT 2B	Brown/White		14
Reserved	Purple/White	Reserved cable	15
AC24V1	Red	Power supply, connect to AC24V	-
PNGD	Yellow/Green	Protective grounding	-
AC24V2	Black	Power supply, connect to AC24V	-
BNC	-	Video output, local video output composite video signal	-

[Note]: The wire interface of different models may differ. Please subject to the actual wires on the device and refer to the table above to identify the wires.

IV. Installation

1. Safety Instructions

- The thickness of the wall or ceiling should be able to bear the expansion screws.
- Make sure there is enough space for mounting the camera and its accessories.
- Make sure the wall or cross-bar can bear the weight as heavy as 8 times of the total weight of the camera and the accessories (net weight of outdoor dome camera: 4.5 KG; net weight of indoor dome camera: 2.1 KG).
- On roads without height limits, the suggested installation height of the camera should be higher than 5m so as to reduce friction to the camera.
- To prevent the device from dropping, the camera must be installed with a safety hook during installation.
- During installation, no man shall be allowed to move around in 2m under the camera, and all men should wear a safety helmet.

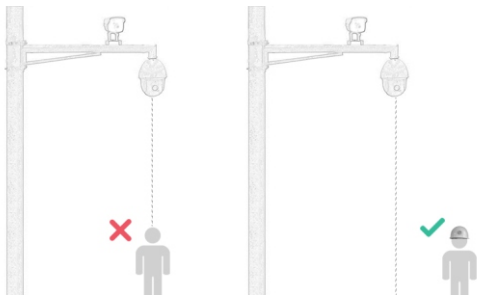

2. Install Storage Card

- 1) Open the transparent dome, take out the anti-vibration sponge, peel off the protective sticker and insert a SD card if necessary.

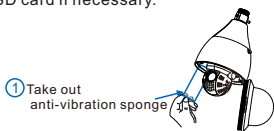

[Note]: The SD card slot location of some models may differ with that in the picture. Please subject to actual models.

- 2) Cover the dome and tighten the screws.

[Attention]: The bottom of the dome is easy to be scratched. Peel off the protective film after finish installation.

3. Installation of Outdoor Dome Camera

The camera supports wall bracket mount, pendent mount, corner bracket mount, pillar bracket mount and self-made bracket mount.

[Note]: All brackets are optional.

Wall Bracket Mount

- 1) Thread the wires through the bracket and reserve a certain length for connecting with the internal wire of the dome camera (20 cm to 30 cm recommended).
- 2) Drill holes in the wall according to the installation sticker, insert expansion screws, align the holes on the bracket to the holes on the wall, insert screws and tighten up.

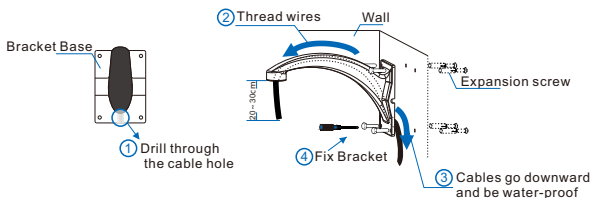

Cables go through the bracket base

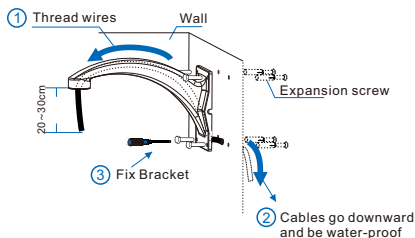

Cables go through the wall

- 3) Bind thread seal tape around the screw thread part of the connector, screw up the connector onto the bracket and tighten the pins on the bracket. Make sure that the anti-off screw on the connector is loose.

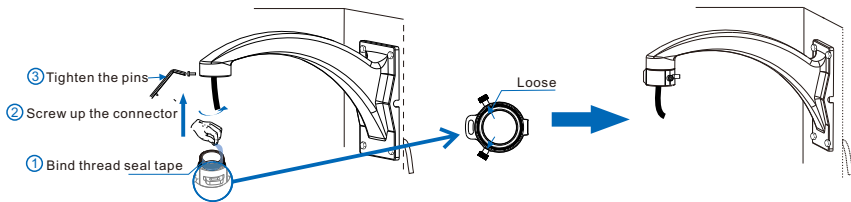

- 4) Take out the hook and hang it on the hanger of the connector.

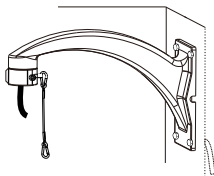

- 5) Twist off the screw on the housing, rotate as the sticker indicates and split the housing round about.

[Note]: The split housing has an internal anti-drop wire connecting with the dome camera. The following installation diagrams are for your reference only.



- 6) Hang the safety hook and thread the wires through the upper housing. Align the straight side of D-shaped head to connector sticker, then push the head till the end, and rotate 180° and align to the yellow sticker, then the dome camera is fixed. Tighten the 2 anti-off screws.

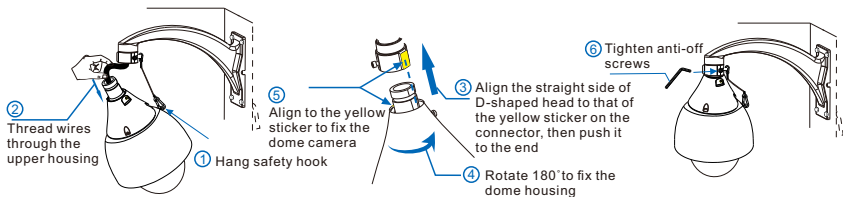

7) Twist off the 2 positioning screws on the upper housing and open the upper housing.



8) Connect cables as the sticker in the dome camera indicates. Afterwards, examine and sort all cables, tighten them with insulating tape and make a water-proof curve.

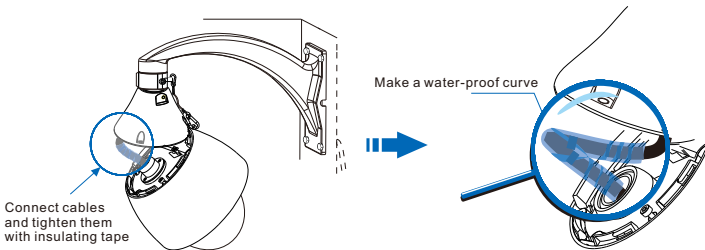

- 9) Make sure that cables are well sorted and bound. Lead the bound cables through the positioning part and pull them tight.

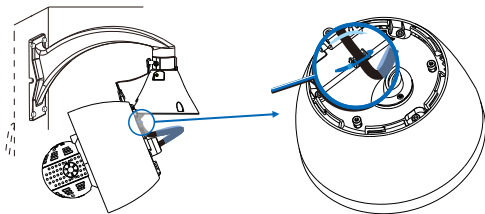

- 10) Cover the upper housing and fix it tight with 2 positioning screws.

- 11) Install the housing: connect the split housings tight, align the dot on the housing, rotate and align it to the sticker, and tighten the screws on the split housings.

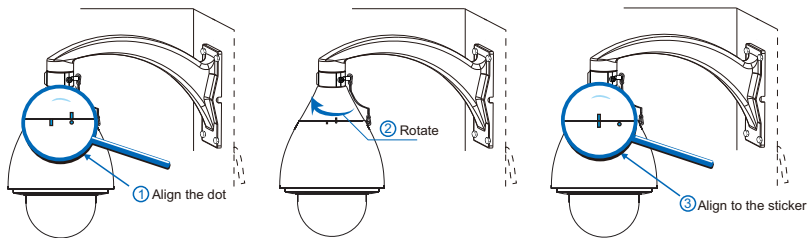

- 12) After finish installation, peel off the protective film and power on the device.

Pendent Bracket Mount

Please refer to the Wall Bracket Mount for the installation of the connector and the dome camera.

- 1) Thread the wires through the bracket and reserve a certain length for connecting with the internal wire of the dome camera (20 cm to 30 cm recommended).
- 2) Drill holes on the wall according to the installation sticker, insert expansion screws, align the holes on the bracket to the holes on the wall, insert screws and tighten up.

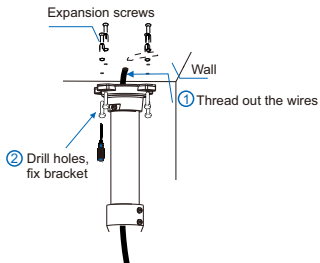

Corner Bracket Mount

Please refer to the Wall Bracket Mount for the installation of the connector and the dome camera.

- 1) Thread the wires through the bracket and reserve a certain length for connecting with the internal wire of the dome camera (20 cm to 30 cm recommended).
- 2) Draw and drill holes on the wall according to the holes on the corner bracket, insert expansion screws and fix the corner bracket.
- 3) Align the holes on the wall bracket base to the holes on the corner bracket, insert screws and tighten them up.

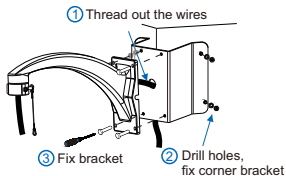

Pillar Bracket Mount

Please refer to the Wall Bracket Mount for the installation of the connector and the dome camera.

- 1) Unscrew the clamp on the pillar bracket.
- 2) Thread the wires through the bracket and reserve a certain length for connecting with the internal wire of the dome camera (20 cm to 30 cm recommended).
- 3) Fix the pillar bracket onto the mounting pillar, tighten the clamp and fix the bracket;
- 4) Align the holes on the wall bracket base to the holes on the pillar bracket, insert screws and tighten them up.

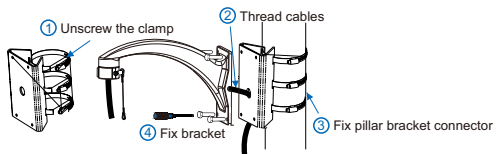

Self-Made Bracket Mount

User can install the camera with self-made bracket with at least 2 pins. This guide will take the cross-bar bracket as an example.

- 1) Get a welded cross-bar ready and there must be at least 2 pins mounted 10mm~13mm from the mounting port;

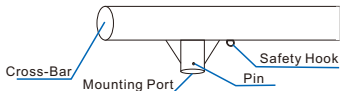

- 2) Thread the cables out from the bracket and reserve enough length for connecting to the cables in the dome camera (suggest reserving 20cm~30cm);

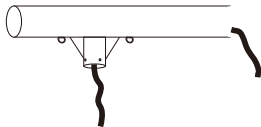

- 3) Take out the safety hook and hang one end of it onto the hook of the cross-bar;

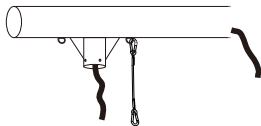

- 4) For the installation of dome camera, please refer to the steps of Wall Bracket Mount.

4. Installation of Indoor Dome Camera

The camera supports embedded mount and ceiling mount.

Embedded Mount

Before embedded mount, please install the storage card first. Please refer to the part of *Install Storage Card* for the installation steps.

[Note]: The embedded bracket is optional.

- 1) Mount the bracket: align the cable holes and fix the bracket with screws;
- 2) Paste the installation sticker on the ceiling, and drill holes;
- 3) Connect cables as the sticker on the housing indicates. Afterwards, examine and sort out the cables, and tighten them with insulating tape;
- 4) Make sure that cables are well sorted and bound. Thread the bound cables through the positioning part and pull them tight;

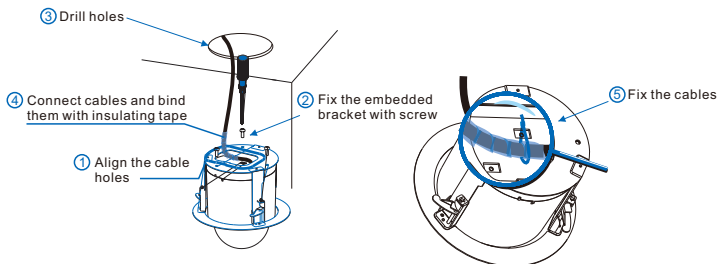

- 5) Push the camera into the cable hole, adjust it to a suitable position and tighten the screws to make sure the supporting plate clamps the ceiling tight;

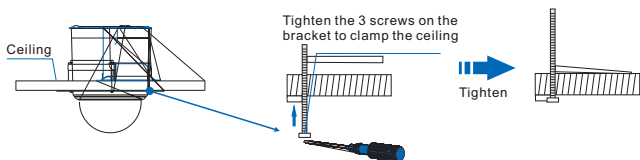

- 6) Install the decorative housing.

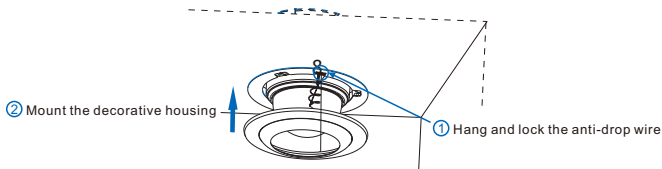

Ceiling Mount

- 1) Rotate to take off the housing and install the storage card. Please refer to the part of *Install Storage Card* for the installation steps.
- 2) After confirm the mounting position, paste the installation sticker on the ceiling, drill holes as the sticker indicates and insert the expansion screws.

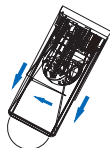

Rotate to take off the housing

- 3) Connect cables as the sticker on the housing indicates. Afterwards, examine and sort out the cables, and tighten them with insulating tape.
- 4) Make sure the cables are well sorted and bound. Thread the bound cables through the positioning part and pull them tight.

- Top cabling: must reserve a cable hole on the mounting surface, and thread the tail wire out.
- Side cabling: drill a cable hole on the base with pincer pliers, and thread the tail wire out.

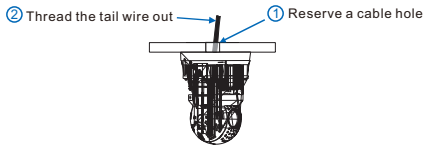

Top Cabling

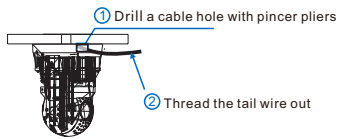

Side Cabling

- 5) After threading the wires, fix the base onto the ceiling with 3 tapping screws.
- 6) When installing the housing, align the convex part on the housing to that on the base, push the housing tight and rotate it till where the indicator is.

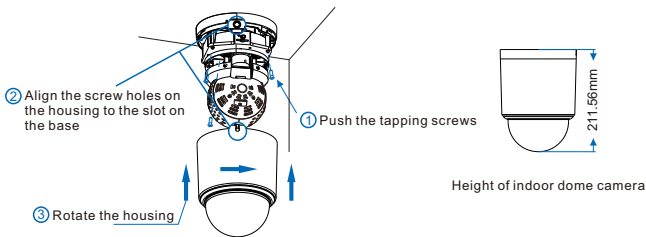

V. Login to the Device

1. Minimum system configuration and environment requirements:

- Processor: 3.3 GHz CORE®i2 series or other equivalent processors
- RAM Memory: 4GB or above
- Operating System: Windows XP or higher versions
- Browser: recommend IE kernel browsers, otherwise some functions of the web client may fail
- DirectX : 9.0c

2. Device Activation

When using the device for the first time, run IPCSearch and it will search devices in LAN automatically and display the list of device IP address, gateway and etc. If the network provides DHCP service, DHCP server will assign IP for the camera automatically.

- Batch: Select the device and click "**Batch processing**". In the popup interface, set admin user's password and the email address to find back the password. Click "**Activate**" and wait for rebooting.
- Individual: Select the device from IPCSearch and right click to select "**Active**". Fill admin user name and password and the e-mail address to find back the password. Click "**Activate**" and wait for rebooting.
- Web client: the device can also be activated through the web client. Set PC and the device in the same network segment and login to the web. User can set admin password and password reset email on the interface and click "**Activate**".

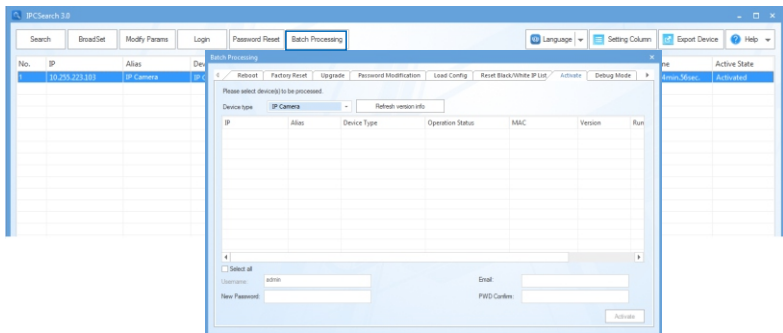

Login



3. Modify Device IP Address

Click **Modify Params** and set the network parameters. When configuring a static IP for the camera, please check **Custom device address (Close DHCP)** and fill the Ethernet parameter. During the modification, the user name (admin) and the password set before activation should be entered. After configuration, the camera will reboot automatically.

4. Login to the Device

- 1) Double click the device in IPCSearch or click **Login**. Enter user name and password to login the web client.
- 2) After login, download and install the plug-in.
- 3) Re-login to the web client and view live video directly.

[Note]: Interface of different models may differ. Please subject to the actual products. Please refer to the *Help* file for detailed explanation.

Adjust camera direction, configure camera parameters in web client until the live view meets the requirements.

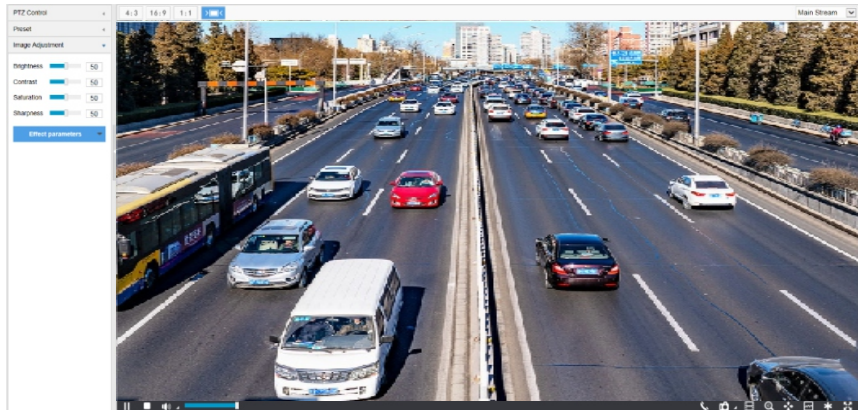

Appendix I:

Waterproof

- For outdoor mounting, suggest applying wall mounting bracket whose cross-bar has an upward angle.
- If user uses self-selected bracket, suggest applying those waterproof brackets with female screw thread connector. If user selects brackets with male screw thread, make sure of the waterproofness of the connecting part between the bracket and the high speed dome camera.
- The screw thread connector needs to be bound with thread seal tape to ensure the sealing tightness of screw thread. When mount, align with the screw thread to avoid obvious deviation or slipping.
- The O-ring seal for the transparent housing of dome camera must be mounted to prevent vapor or dust penetration.

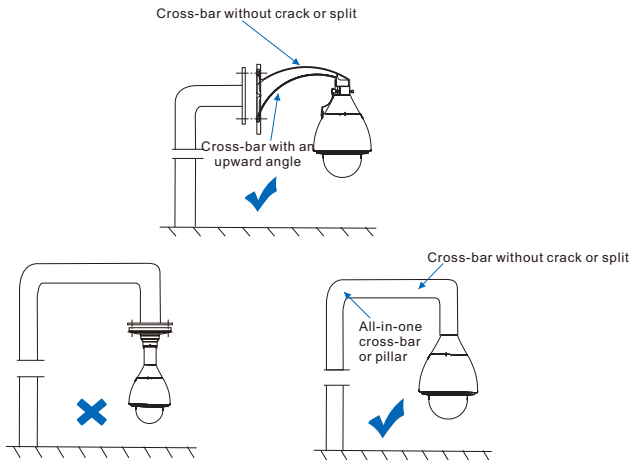

Anti-static, Anti-interference, Anti-thunder, Anti-surge

- The camera should be grounded, or ESD may damage the electrical parts.
- In thunder and lightning area, camera should be grounded nearby to release the heavy energy of thunder strike so as to prevent camera from damage.
- In area with unstable voltage, camera should be grounded to release the heavy energy of electrical surge so as to prevent power source from burning.

- Camera anti-thunder ground lead cannot replace safety ground lead. When apply pillars with imperfect earth, such as wooden pillar and cement pillar, camera should connect the safety ground lead to release leak current so as to ensure the safety of camera or pillar.
- Camera anti-thunder ground lead must be grounded individually, other than being grounded through other electrical device nearby.

[Cement Pillar Ground]

Cement pillar mounting needs protective steel pipe to lead the ground wire. As the picture shows, the ground wire of high speed dome camera goes through the steel pipe and grounds. The Command Center just has to ground locally according to the norms.

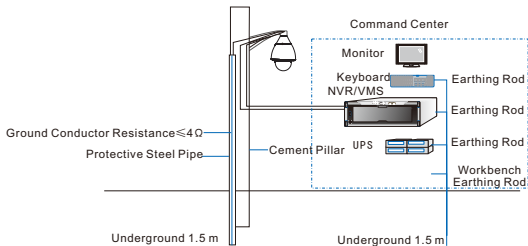

Cement Pillar Ground

[Metal Pillar Ground]

Metal pillar mounting needs PVC pipe to lead the ground wire. Metal pillar without lightning rod applies PVC pipe to lead ground wire. Fix the ground wire near the metal pillar and ground it, as the picture shows.

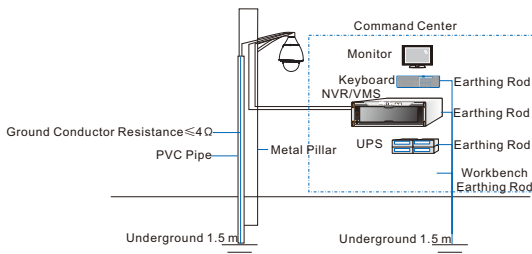

Metal Pillar Ground

Metal pillar with lightning rod applies inside PVC pipe to lead ground wire, and the PVC pipe should keep an insulation distance from the inner wall of metal pillar as far as possible, as the picture shows.

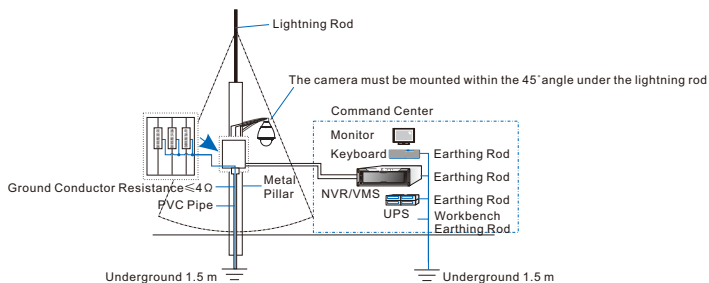

Metal Pillar Ground with Lightning Rod

[Attention]: If there is middleware installed, such as optical transceiver or anti-thunder device, the middleware should be well grounded and the camera should also be well grounded if the cable goes through the middleware.

Appendix II: AC 24V Wire Diameter VS. Transmission Distance

The recommended max transmission distance when the wire diameter is certain and the AC24V voltage loss rate is less than 10%

(For AC24V powered devices, the maximum allowed voltage loss rate is 10%. All the wires in the following table are cooper wires, whose electrical resistivity is $\rho = 0.0175\Omega \cdot \text{mm}^2/\text{m}$)

Distance m (feet) Power W	Diameter mm	0.8 (20AWG)	1.0(18AWG)	1.25(16AWG)	2.0(12AWG)
5		122 (401)	194 (636)	307 (1008)	781 (2562)
10		61 (201)	97 (318)	154 (504)	391 (1281)
15		41 (134)	65 (212)	102 (336)	260 (854)
20		31 (100)	48 (159)	77 (252)	195 (641)
25		24 (80)	39 (127)	61 (202)	156 (512)
30		20 (67)	32 (106)	51 (168)	130 (427)
35		17 (57)	28 (91)	44 (144)	112 (366)
40		15 (50)	24 (79)	38 (126)	98 (320)
45		14 (45)	22 (71)	34 (112)	87 (285)
50		12 (40)	19 (64)	31 (101)	78 (256)
55		11 (36)	18 (58)	28 (92)	71 (233)
60		10 (33)	16 (53)	26 (84)	65 (214)
65		9 (31)	15 (49)	24 (78)	60 (197)
70		9 (29)	14 (45)	22 (72)	56 (183)
75		8 (27)	13 (42)	20 (67)	52 (171)
80		8 (25)	12 (40)	19 (63)	49 (160)
85		7 (23)	11 (37)	18 (59)	46 (151)
90		7 (22)	11 (35)	17 (56)	43 (142)
95		6 (21)	10 (33)	16 (53)	41 (135)
100		6 (20)	10 (32)	15 (50)	39 (128)

[Note]: The requirements of diameter apply to single, solid and round cooper wire. The AWG value of multi-stranded wires depends on the total CSA (Cross Sectional Area) of all wires.

Kedacom Two (2) Year Limited Hardware Warranty

WHAT IS COVERED BY THIS WARRANTY?

Kedacom warrants the Kedacom-branded hardware product and accessories contained in the original packaging (hereinafter referred to as "Kedacom Product") against defects in materials and workmanship when used normally in accordance with Kedacom's published guidelines for a period of TWO (2) YEARS from the date of original retail purchase in areas other than mainland China by the end-user purchaser (hereinafter referred to as "Warranty Period"). For the Kedacom Product purchased in mainland China, see the simplified Chinese version of this warranty for details. Kedacom's published guidelines include but are not limited to information contained in technical specifications, user guides, and service communications. The preceding applies unless otherwise agreed in the contract.

WHAT IS NOT COVERED BY THIS WARRANTY?

This warranty does not apply to any non-Kedacom branded hardware products or any software, even if packaged or sold with Kedacom hardware. Manufacturers, suppliers, or publishers, other than Kedacom, may provide their own warranties to you but Kedacom, in so far as permitted by law, provides their products "AS IS". Software distributed by Kedacom with or without the Kedacom brand (including, but not limited to system software) is not covered by this warranty. Please refer to the licensing agreement accompanying the software for details of your rights with respect to its use. Kedacom does not warrant that the operation of the Kedacom Product will be uninterrupted or error-free. Kedacom is not responsible for damage arising from failures to follow instructions relating to the Kedacom Product's use.

This warranty does not apply: (a) to consumable parts, such as batteries, unless failure has occurred due to a defect in materials or workmanship; (b) to cosmetic damage, including but not limited to scratches, dents, and broken plastic on ports; (c) to damage caused by use with another product; (d) to damage caused by acts outside the control of Kedacom, including without limitation acts of God, accidents, abuse, misuse, fire, storms, earthquakes, flood, or other external cause; (e) to damage caused by exposure of the product to heat, bright light, sun, liquids, sand, or other contaminants; (f) to damage caused by operating the Kedacom Product outside Kedacom's published guidelines; (g) to damage caused by service (including upgrades and expansions) performed by anyone other than a representative of Kedacom, Kedacom employee, or authorized Kedacom agent; (h) to an Kedacom Product that has been modified to alter functionality or capability without the written permission of Kedacom; (i) to defects caused by normal wear and tear or otherwise due to the normal aging of the Kedacom Product, or (j) if any serial number has been removed or defaced from the Kedacom Product.

YOUR RESPONSIBILITIES

If your Kedacom product is capable of storing data and other information, you should make periodic backup copies of the information contained on the storage media to protect the contents and as a precaution against possible operational failures.

Before receiving warranty service, Kedacom or its authorized agents may require that you furnish proof of purchase details, respond to questions designed to assist with diagnosing potential issues, and follow Kedacom's procedures for obtaining warranty service. Before submitting your Kedacom Product for warranty service, you should maintain a separate backup copy of the contents of its storage media, remove all personal information that you want to protect, and disable all security passwords.

During warranty service, it is possible that the contents of the Kedacom product's storage media will be lost, replaced or reformatted. In such an event, Kedacom and its authorized agents are not responsible for any loss of data or other information contained on the storage media or any other part of the Kedacom product serviced.

Following warranty service, your Kedacom Product or a replacement product will be returned to you as your Kedacom Product was configured when originally purchased, subject to applicable updates. You will be responsible for reinstalling all other data and information. Recovery and reinstallation of other data and information are not covered under this warranty.

WHAT WILL KEDACOM DO IF THE WARRANTY IS BREACHED?

If during the Warranty Period, you submit a valid claim to Kedacom or an authorized Kedacom agent, Kedacom will, at its option, (i) repair the Kedacom Product using new or previously used parts that are equivalent to new in performance and reliability, or (ii) exchange the Kedacom Product for a refund of your purchase price.

A Kedacom replacement part or product, including a user-installable Kedacom part that has been installed in accordance with instructions provided by Kedacom, assumes the remaining warranty of the Kedacom Product or ninety (90) days from the date of replacement or repair, whichever provides longer coverage for you. When a product or part is replaced or a refund provided, any replacement item becomes your property and the replaced or refunded item becomes Kedacom's property.

Kedacom reserves the right to refund the purchase price as its exclusive warranty remedy.

HOW TO OBTAIN WARRANTY SERVICE?

To seek warranty service, please contact a local authorized Kedacom agent. When contacting the agent via telephone, other charges may apply depending on your location.

User Information

Complete the form below and keep for ready reference.

User Name:	
Address:	Postal Code:
Tel:	Mobile:
Fax:	E-Mail:
Product Name:	Product Model:
Date of Purchase:	

客户咨询热线：400-828-2866

KEDACOM

苏州科达科技股份有限公司

Suzhou Keda Technology Co.,Ltd.

中国: 江苏省苏州市高新区金山路131号(215011)

Tel: +86-512-6841 8188 Fax: 86-512-68412699

Suzhou Keda Technology Co.,Ltd.

Singapore: 627A Aljunied Road, #09-07, BizTech Centre, Singapore 389842

Tel: +65-6842-5700 Fax: +65-6842-5900

05.03.800917 (V4.2) 20200507